

DIN Panels and Accessories

The Lutron family of DIN rail panels are designed to accept the Lutron DIN power modules (DPMs). The DPMs can be configured in the panel to control multiple load types that fit the size, lighting plan and design of a home. The control panels have a control gear compartment that can house up to 2 processors, DMX and/or IO interfaces, 2 Wire Landing Boards (WLB), and 1 power supply. The satellite panels replace the control gear compartment with a mounting bracket to add an additional DPM. Panels may be either surface-mounted or recess-mounted in an electrical closet or other equipment room. There are feed-through, MCB and RCBO options available for each panel size and type. For each DPM type, there is a terminal kit available as well as a wiring harness. There is also a QS harness for wiring from DPM to DPM. Other options include blanking plates for unused module positions and a reversible hinged door.

Features

- Panels house LQSE DIN power modules (DPMs)
 - LQSE-4A-D – LQSE-4M-D – LQSE-4S10-D
 - LQSE-2ECO-D – LQSE-4T10-D – LQSE-2DAL-D
 - LQSE-4A1-D – LQSE-4S5-230-D – LQSE-4A5-230-D
- Control panels support
 - HQP6-2 (HomeWorks QS Processor) – QS-WLB
 - QSE-IO – QSE-CI-DMX
 - QSPS-DH-1-75 or QSPS-DH-1-60
- Feed-through, MCB and RCBO panels available.
- Panels extensively tested to ensure optimal thermal performance with maximum load in 0 °C to 40 °C (32 °F to 104 °F) ambient environment.
- Schneider Electric® commercial grade breakers.
- Panels with breakers include a main isolation (ISO) switch.
- Panels with breakers include pre-installed and verified wiring from an ISO switch to breakers.
- Bypass jumpers included for miswire protection.
- Panels are rated for 220–240 V~ CE and non-CE applications.
- Integral manual override switch turns all lights on to the programmed override level when activated.
- Panels are available in two sizes: 1 613 mm (63.50 in) and 921 mm (36.28 in).
- Reversible hinged door option available.
- Terminal Block kits available for each DPM type.
- Pre-assembled wiring harnesses available for each DPM type.
- Pre-assembled wiring harness available for QS link from DPM to DPM.
- Additional live and neutral feeds provided to add breakers in the field for LQSE-2ECO-D and LQSE-2DAL-D modules.

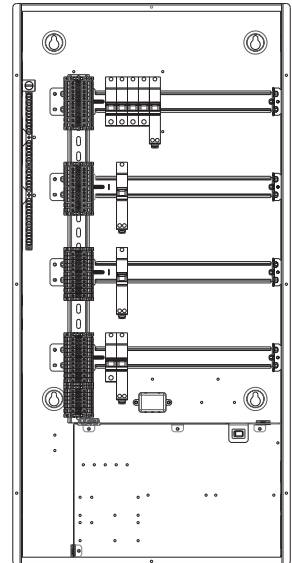

PD4-36-RU10-2L4

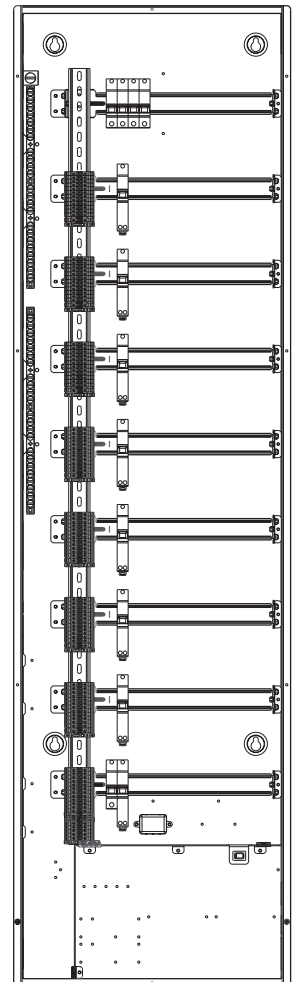

PD8-64-RU10-2L4

DIN Panels and Accessories

Specifications

Model Numbers	PD10-64-F; PD10-64-BU10-2L4; PD10-64-RU10-2L4; PD10-64-BU10-2L2; PD10-64-RU10-2L2; PD9-64-F; PD9-64-BU10-2L4; PD9-64-RU10-2L4; PD9-64-BU10-2L2; PD9-64-RU10-2L2; PD8-64-F; PD8-64-BU10-2L4; PD8-64-RU10-2L4; PD8-64-BU10-2L2; PD8-64-RU10-2L2; PD5-36-F; PD5-36-BU10-2L4; PD5-36-RU10-2L4; PD5-64-BU10-2L2; PD5-64-RU10-2L2; PD4-36-F; PD4-36-BU10-2L4; PD4-36-RU10-2L4; PD4-64-BU10-2L2; PD4-64-RU10-2L2
Power	Feed-through: 220-240 V~ 50/60 Hz 10 A per input maximum Breaker and RCBO (3 phase 4-wire feed): 220-240 V~ 125 A input Breaker and Feed-through (1 phase, 2-wire feed): 220-240 V~ 63 A input
Capacity	<p>PD4-36: Four DPMs* in any combination, two Wire Landing Boards (WLB), one power supply unit and two Interface boxes or processors. The top position supports LQSE-4S10-D module only in MCB and RCBO breaker panels.</p> <p>PD5-36: Five DPMs* in any combination, two Wire Landing Boards (WLB). The top position supports LQSE-4S10-D module only in MCB and RCBO breaker panels.</p> <p>PD8-64: Eight DPMs* in any combination, two Wire Landing Boards (WLB), one power supply unit and two Interface boxes or processors.</p> <p>PD9-64: Nine DPMs* in any combination, two Wire Landing Boards (WLB), one power supply unit and two Interface boxes or processors. The top position supports LQSE-4S10-D module only in MCB and RCBO breaker panels.</p> <p>PD10-64: Ten DPMs* in any combination, two Wire Landing Boards (WLB). The top position supports LQSE-4S10-D module only in MCB and RCBO breaker panels.</p> <p>80 A of dimming current maximum in PD9 and PD10 panels.</p>
Regulatory Approvals	CE
Environment	Ambient operating temperature: 0 °C to 40 °C (32 °F to 104 °F), 0 to 90% humidity, non-condensing. Indoor use only. Door is required if LQSE-4A-D/LQSE-4A5-230-D module is used and calibration point exceeds 70 °C (158 °F). See optional accessories for door models.
Cooling	Passive cooling
Line-Voltage Connections	Use copper wire only. In a feed-through panel, DIN rail-mounted terminal blocks are provided for line-voltage to DPM, and power supply wiring (if applicable). In a panel with breakers, ISO switch is provided for line voltage to MCB or RCBO breakers to power the DPM.
DIN Rail Terminal Blocks	Terminal blocks will accept one 0.75 mm ² to 6.0 mm ² (18 AWG to 10 AWG) wire or two 0.75 mm ² to 1.5 mm ² (18 AWG to 14 AWG) wires. Terminal blocks should be tightened to 0.60 N•m to 0.8 N•m (5.3 in-lb to 7.1 in-lb).
ISO Switch	3 phase 4-wire ISO switch will accept one 2.5 mm ² to 35 mm ² (14 AWG to 2 AWG) wire. Terminals should be tightened to 3.5 N•m (31 in-lb); 1 phase 2-wire ISO switch will accept one 2.5 mm ² to 35 mm ² (14 AWG to 2 AWG) wire. Terminals should be tightened to 3.5 N•m (31 in-lb).

* 220-240 V~ LQSE-4A-D, LQSE-4A5-230-D, LQSE-4S10-D, LQSE-4T10-D, LQSE-4M-D, LQSE-2ECO-D, LQSE-2DAL-D. Use of non-Lutron equipment in the panel voids the warranty.

DIN Panels and Accessories

Specifications *(continued)*

Ground Bar Terminals	PD4 and PD5: 25 ground termination points PD8, PD9, and PD10: 50 ground termination points
Miswire Protection	All terminal blocks are shipped with bypass jumpers installed. After verifying that each circuit is wired correctly, remove the bypass jumpers for system operation.
Dimensions	<p>PD4 and PD5: Panel: 455 mm x 921 mm x 107 mm (17.93 in x 36.28 in x 4.21 in) Cover: 467 mm x 921 mm (18.38 in x 36.28 in) Cover Thickness: 1.5 mm (0.060 in)</p> <p>PD8, PD9, and PD10: Panel: 455 mm x 1 613 mm x 107 mm (17.93 in x 63.50 in x 4.21 in) Cover: 467 mm x 1 613 mm (18.38 in x 63.50 in) Cover Thickness: 1.5 mm (0.060 in)</p> <p>PD-36-DOOR: 485 mm x 931 mm x 40 mm (19.09 in x 36.66 in x 1.56 in) PD-64-DOOR: 485 mm x 1 613 mm x 40 mm (19.09 in x 63.88 in x 1.56 in)</p>
EcoSystem and DALI feeds	<p>PD4-36: 1 position pre-wired to install a second MCB and RCBO breaker for LQSE-2ECO-D and LQSE-2DAL-D.</p> <p>PD5-36: 4 positions pre-wired to install a second MCB or RCBO breaker for LQSE-2ECO-D and LQSE-2DAL-D.</p> <p>PD8-64, PD9-64, and PD10-64: 3 positions pre-wired to install a second MCB or RCBO breaker for LQSE-2ECO-D and LQSE-2DAL-D.</p>
Mounting	<p>Install and wire in accordance with all local and national codes. Panel may be surface-mounted or recess-mounted. Mount the panel so that line-voltage wiring will be at least 1 830 mm (72 in) from audio or electronic equipment and wiring. Mount panel using one of the following methods (mounting hardware is not provided):</p> <p>a. Surface-Mount: Use keyholes with bolts sufficient for 50 kg (110 lb) load, M6 bolts recommended.</p> <p>b. Recess-Mount: Use screws sufficient for 50 kg (110 lb) through the corners of the Control Panel. Control Panel is 104 mm (4.1 in) deep past cover mounting tabs (including pedestal).</p> <p>NOTICE: This equipment is air-cooled. Mount in a location where the vented cover will not be blocked. 305 mm (12 in) of clearance in front of the vents is required.</p> <p>NOTICE: Power supply will hum slightly and internal relays will click while in use. Mount in a location where such noise is acceptable.</p> <p>NOTICE: Limit vertical stacking of PD4 and PD5 panels to 2 high. Do not vertically stack PD8, PD9, or PD10 panels.</p>
Construction	<p>Control Panel: 16-gauge galvanized sheet metal (unpainted).</p> <p>Cover: Coated metal cover with ventilation holes. Cover is attached using phillips-head screws (included)</p>
Warranty	www.lutron.com/TechnicalDocumentLibrary/Intl_Warranty.pdf

DIN Panels and Accessories

Model Number Example

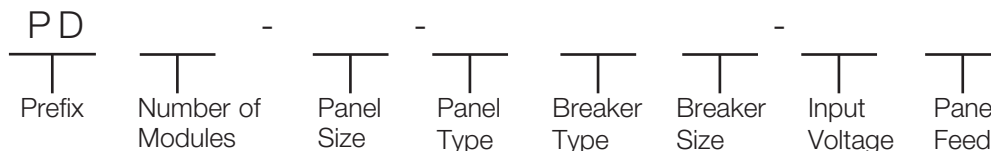

Number of Modules:

- 4 = 4 Modules [control panel]
- 5 = 5 Modules [satellite panel]
- 8 = 8 Modules [control panel]
- 9 = 9 Modules [control panel]
- 10 = 10 Modules [satellite panel]

Panel Size:

- 36 = 921 mm (36.3 in) Enclosure (PD4, PD5)
- 64 = 1 613 mm (63.5 in) Enclosure (PD8, PD9, PD10)

Panel Type:

- F = Feed-through
- B = MCB Input Breaker
- R = RCBO Input Breaker

Breaker Type Country Code:

- U = United Kingdom
- (blank) = Feed-through

Breaker Size:

- 10 = 10 A
- (blank) = Feed-through

Input Voltage:

- 2 = 220–240 V~
- (blank) = Feed-through

Panel Feed:

- L2 = 1 Phase 2-Wire Feed (63 A per input)
- L4 = 3 Phase 4-Wire Feed (125 A per input)
- (blank) = Feed-through

Example: PD8-64-RU10-2L4

8 module 1 613 mm (63.5 in) panel with 10 A RCBO breakers for United Kingdom and 230 V~ 3 phase 4-wire feed

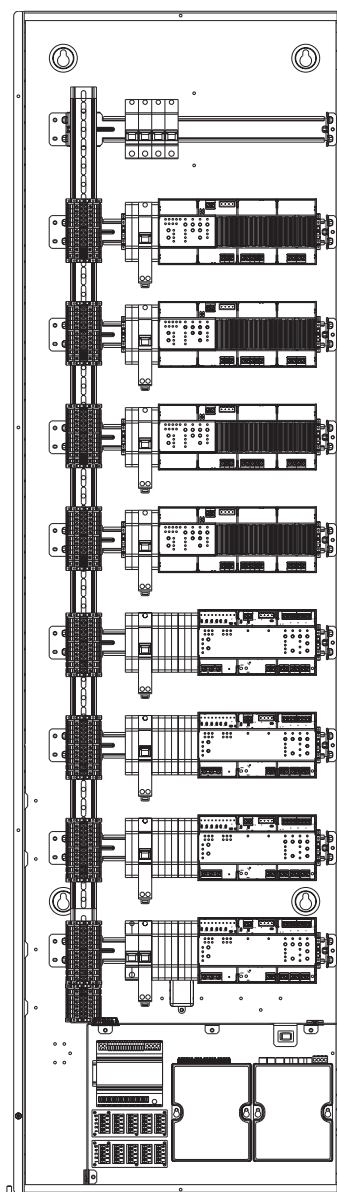

PD8-64-RU10-2L4 Shown with components. Components sold separately.

Customer Assistance:
 1.844.LUTRON1 (U.S.A./Canada)
 +44.(0)20.7680.4481 (Europe)

DIN Panels and Accessories

Optional Accessories

Wiring Harnesses	
PDW-D-1	Wiring Harness for Dimming Power Module
PDW-S-1	Wiring Harness for Switching Power Module
PDW-T-1	Wiring Harness for 0-10 V Power Module
PDW-M-1	Wiring Harness for Motor Control Power Module
PDW-ED-1	Wiring Harness for EcoSystem or DALI Power Module
PDW-QS-4	QS Link Wiring Harness for 4 Power Modules (PD4 panels)
PDW-QS-5	QS Link Wiring Harness for 5 Power Modules (PD5 panels)
PDW-QS-8	QS Link Wiring Harness for 8 Power Modules (PD8 panels)
PDW-QS-9	QS Link Wiring Harness for 9 Power Modules (PD9 panels)
PDW-QS-10	QS Link Wiring Harness for 10 Power Modules (PD10 panels)
Terminal Block Kits	
PDT-DS-1	Terminal Kit for Dimming or Switching Power Module
PDT-T-1	Terminal Kit for 0-10 V Power Module
PDT-M-1	Terminal Kit for Motor Control DIN Power Module
PDT-ED-1	Terminal Kit for EcoSystem or DALI Power Module
Doors	
PD-36-DOOR	Reversible Hinged Door for 921 mm (36.28 in) DIN Panels
PD-64-DOOR	Reversible Hinged Door for 1 613 mm (63.50 in) DIN Panels
Blanks/Fillers	
PD-BLANK-1	DIN Panel Blanking Plate: 1 piece
PD-BLANK-5	DIN Panel Blanking Plate: 5 pieces

DIN Panels and Accessories

Panel Door Dimensions

1 613 mm (63.5 in) panel with optional mounting door. Door can be hung as swing-left or swing-right.

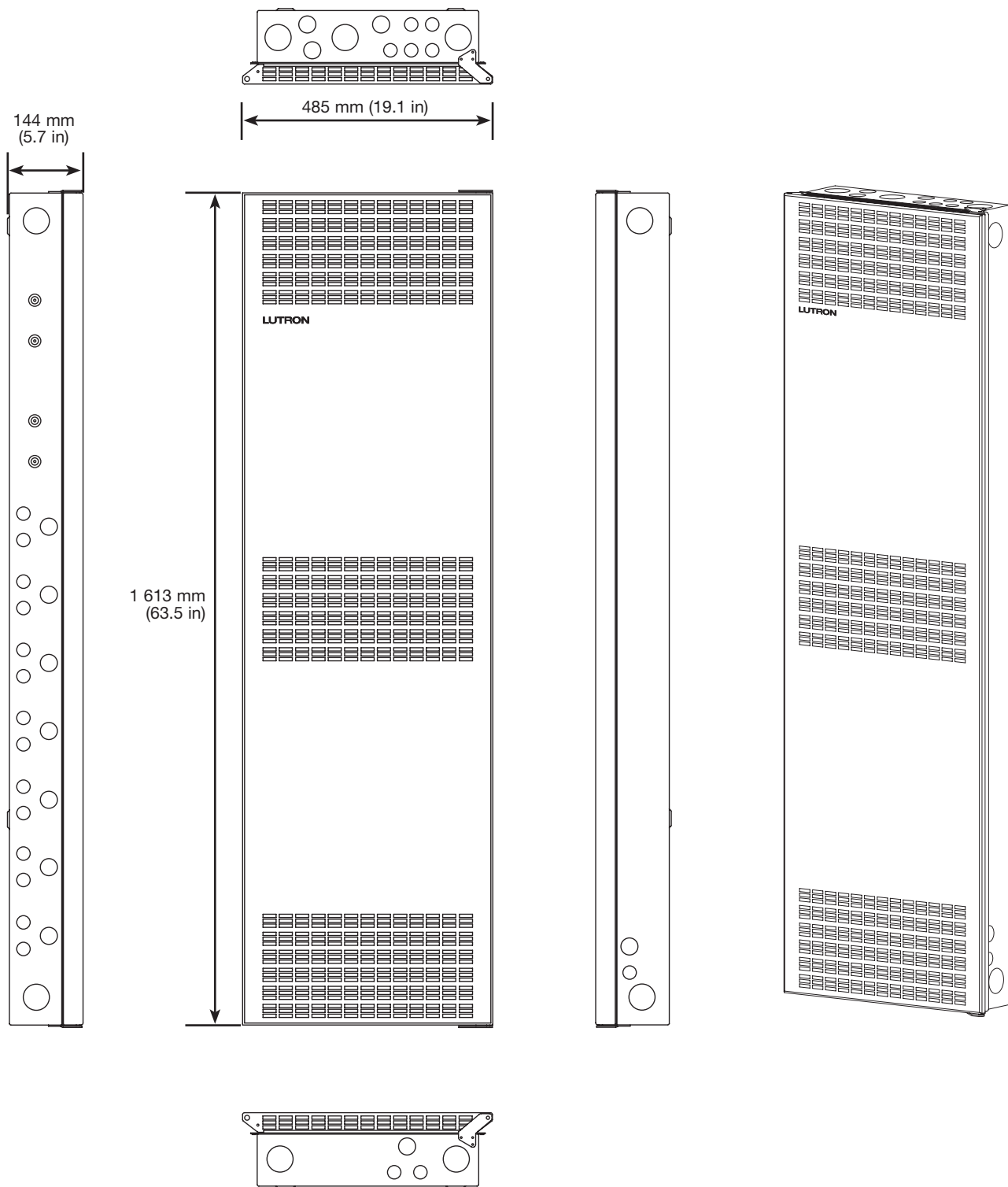

DIN Panels and Accessories

Panel Door Dimensions

921 mm (36.3 in) panel with optional mounting door. Door can be hung as swing-left or swing-right.

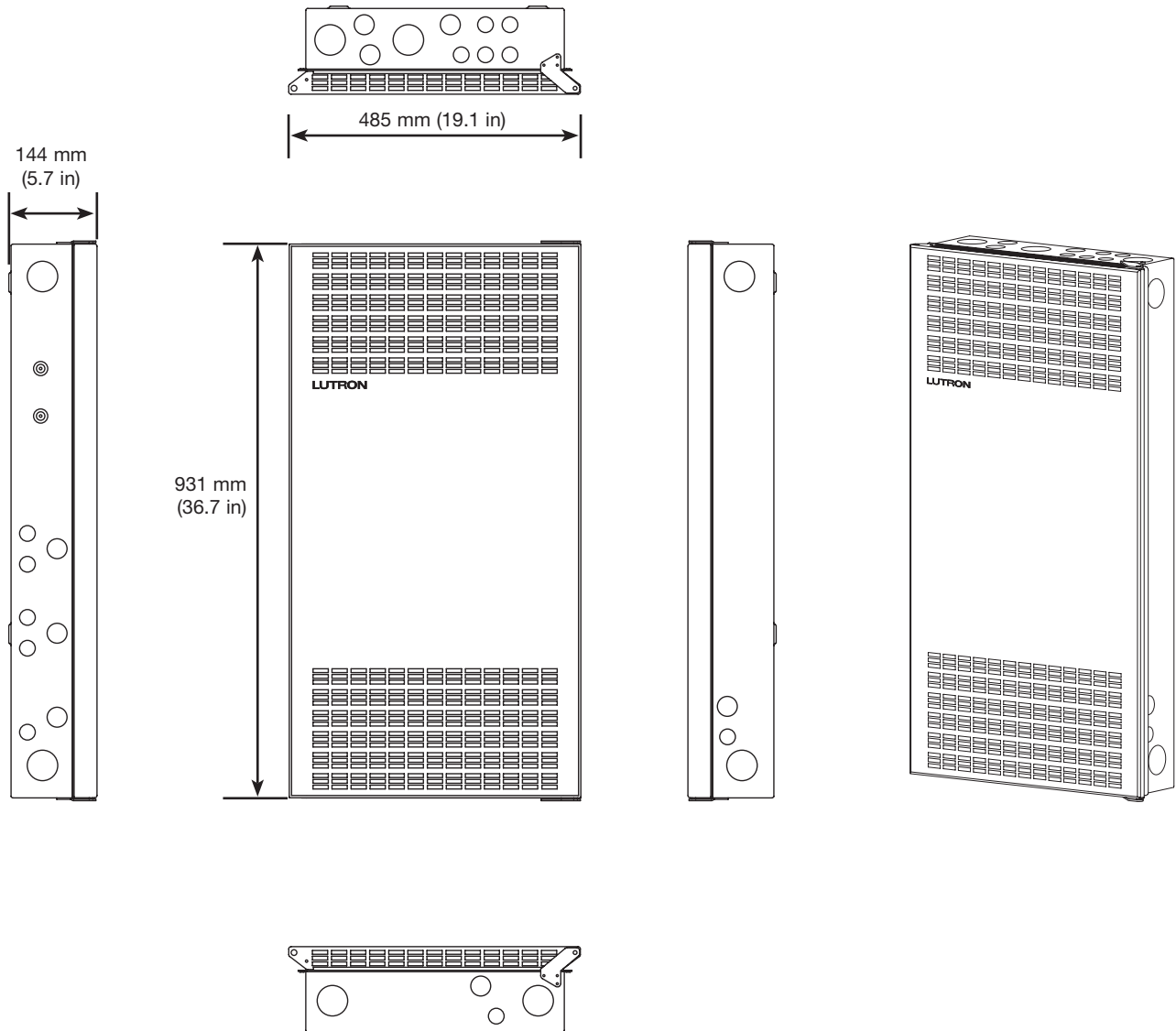

DIN Panels and Accessories

Panel Door Views

Optional door available for 1 613 mm (63.5 in) and 921 mm (36.3 in) panels.
921 mm (36.3 in) panel shown.

Swing-Left

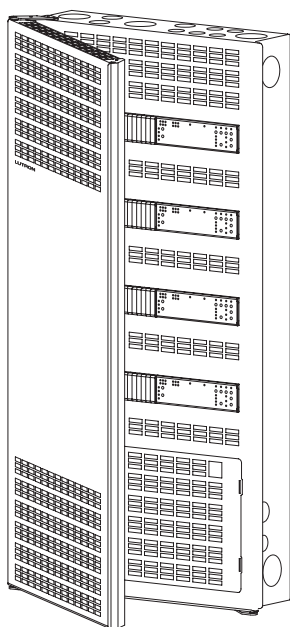

Swing-Right

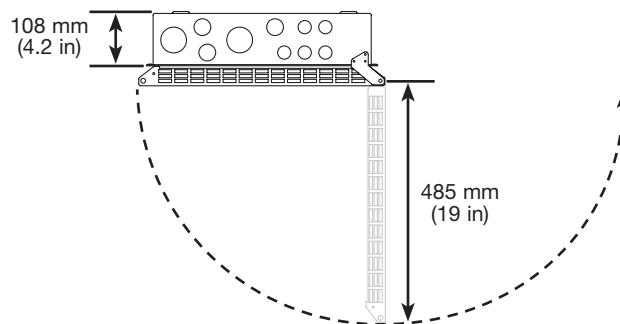
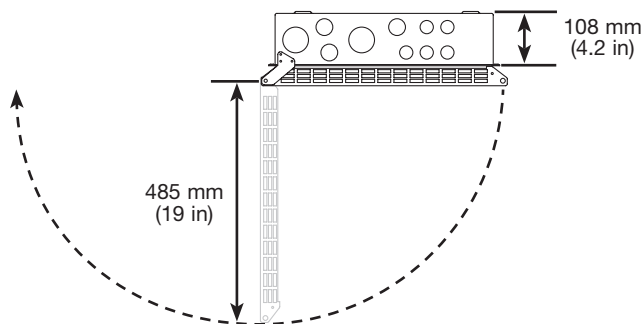
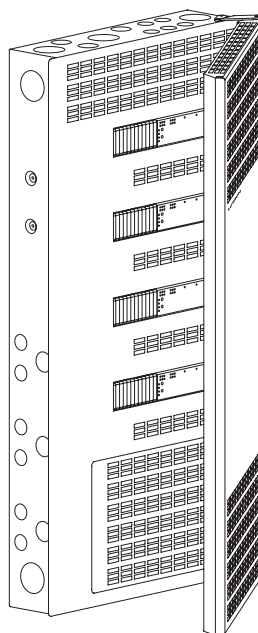

Optional panel door kit includes hinges and mounting hardware that can be configured to swing-left or right. Allow 508 mm (20 in) for swing clearance. Doors have a black, powder-coated finish. Kit can be installed after panel installation, but requires removal and reinstallation of the deadfront (flat cover). Standard door has a magnetic catch.

Panel Door Models:

- PD-64-DOOR
- PD-36-DOOR

DIN Panels and Accessories

Dimensions and Mounting (PD4-36 models):

All PD4-36 models use the same enclosure. All measurements shown as: mm (in)

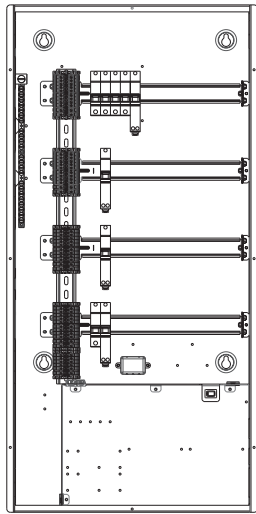
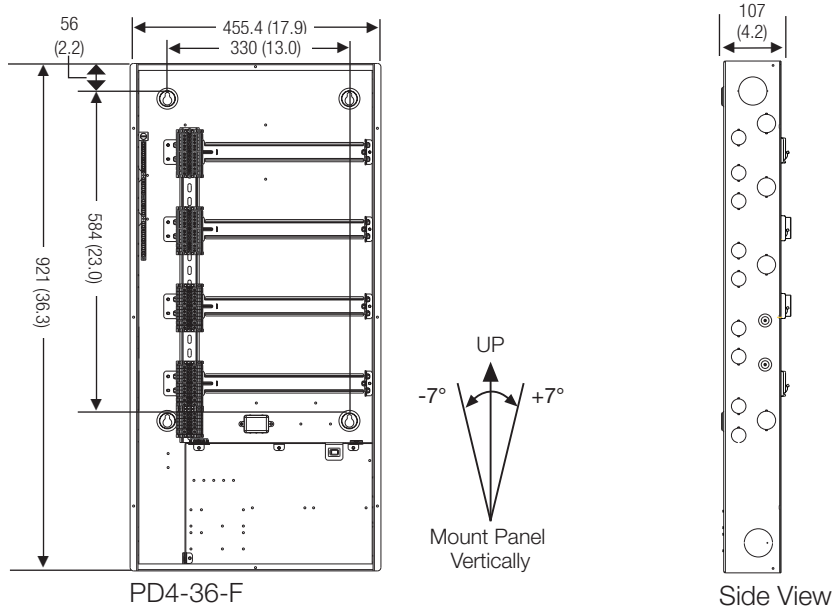

PD4-36-RU10-2L4

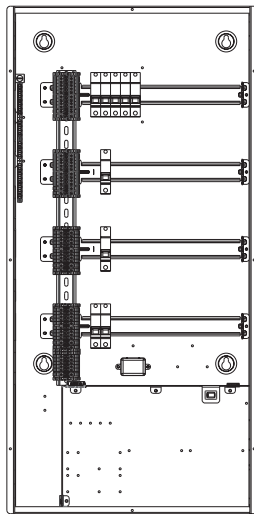

PD4-36-BU10-2L4

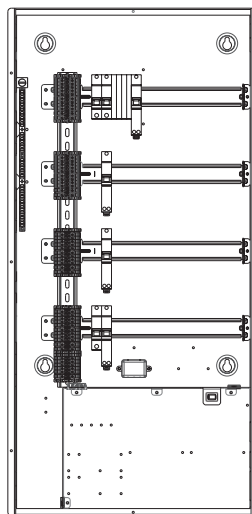

PD4-36-RU10-2L2

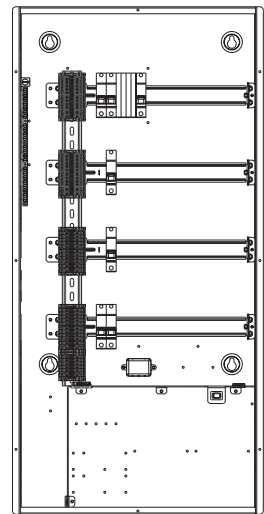

PD4-36-BU10-2L2

DIN Panels and Accessories

Dimensions and Mounting (PD5-36 models):

All PD5-36 models use the same enclosure. All measurements shown as: mm (in)

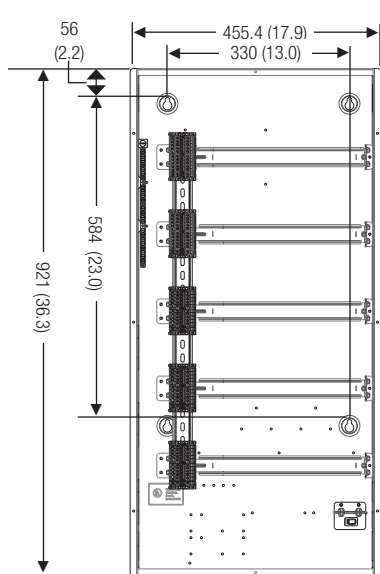

PD5-36-F

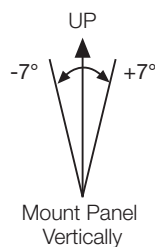

Side View

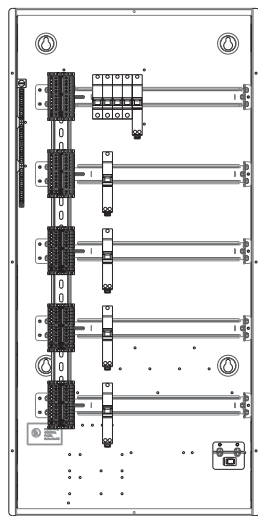

PD5-36-RU10-2L4

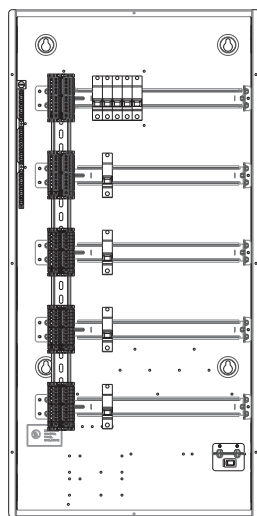

PD5-36-BU10-2L4

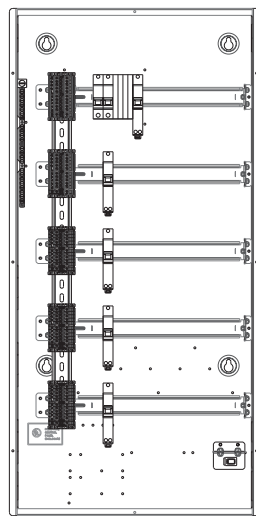

PD5-36-RU10-2L2

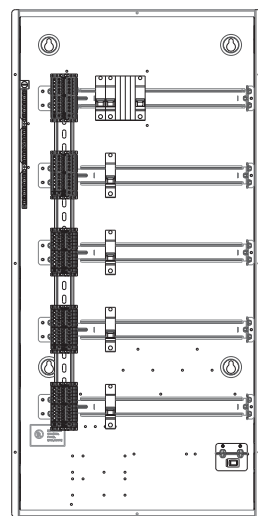

PD5-36-BU10-2L2

Lutron, HomeWorks, and EcoSystem are trademarks or registered trademarks of Lutron Electronics Co., Inc. in the US and/or other countries.

DIN Panels and Accessories

Dimensions and Mounting (PD8-64 models):

All PD8-64 models use the same enclosure. All measurements shown as: mm (in)

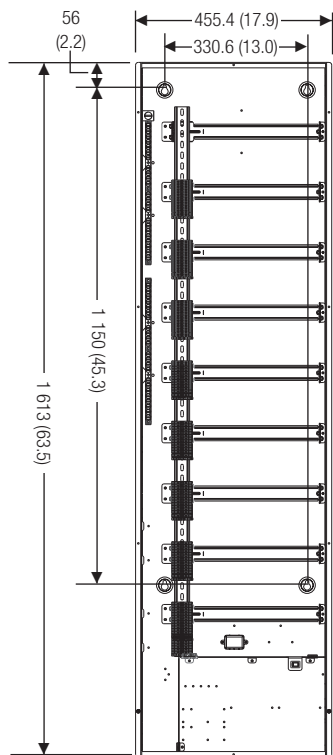

PD8-64-F

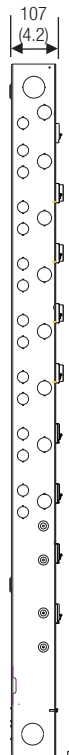
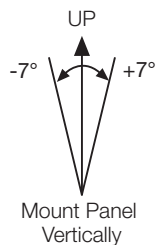

Side View

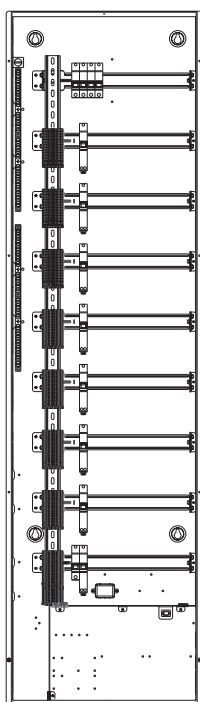

PD8-64-RU10-2L4

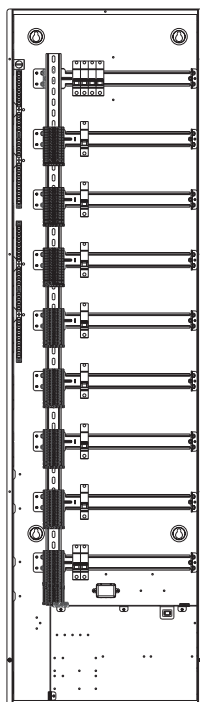

PD8-64-BU10-2L4

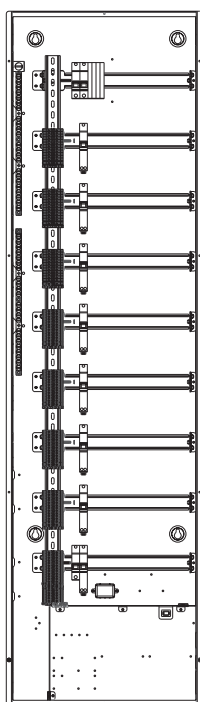

PD8-64-RU10-2L2

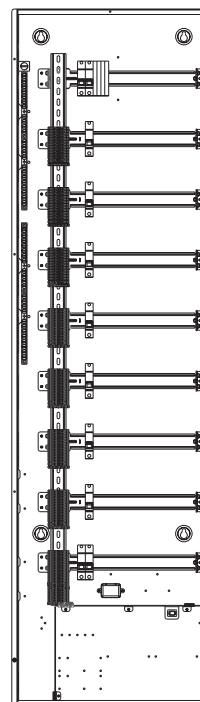

PD8-64-BU10-2L2

DIN Panels and Accessories

Dimensions and Mounting (PD9-64 models):

All PD9-64 models use the same enclosure. All measurements shown as: mm (in)

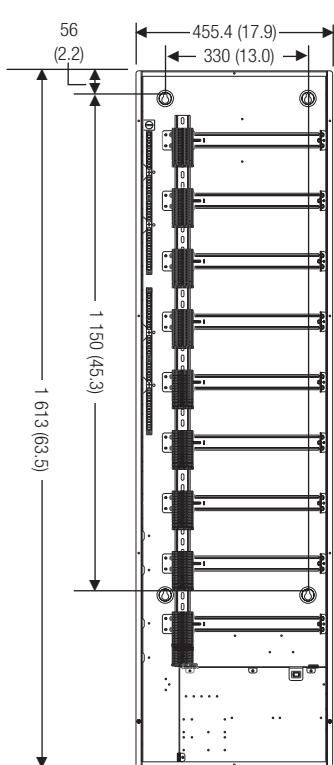

PD9-64-F

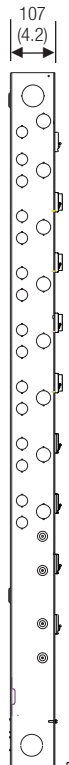
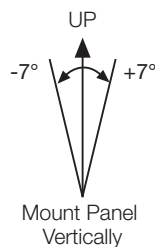

Side View

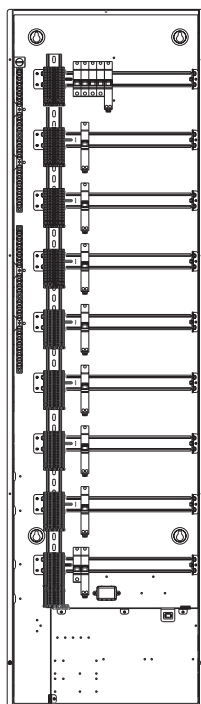

PD9-64-RU10-2L4

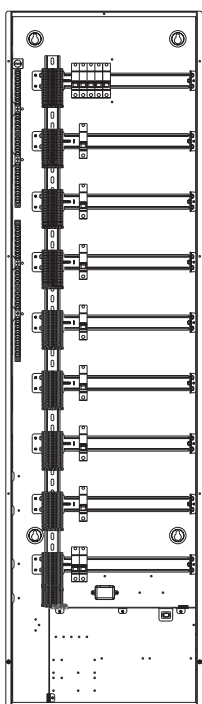

PD9-64-BU10-2L4

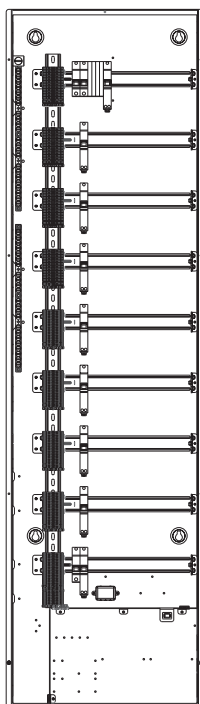

PD9-64-RU10-2L2

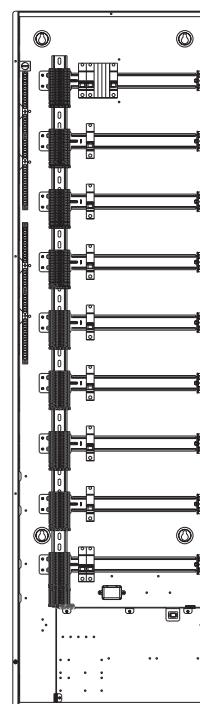

PD9-64-BU10-2L2

DIN Panels and Accessories

Dimensions and Mounting (PD10-64 models):

All PD10-64 models use the same enclosure. All measurements shown as: mm (in)

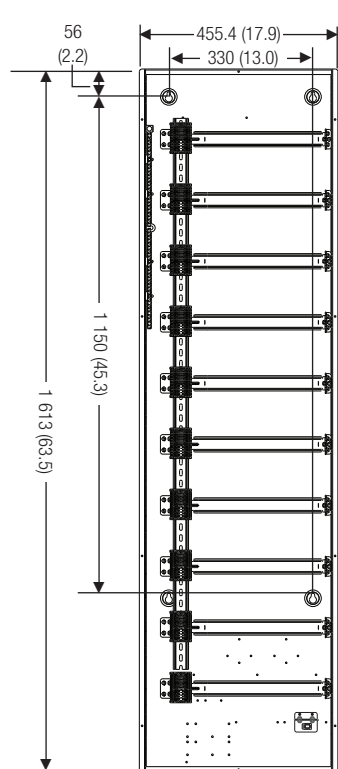

PD10-64-F

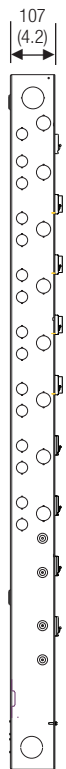
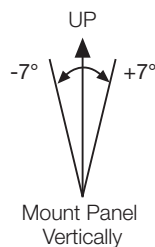

Side View

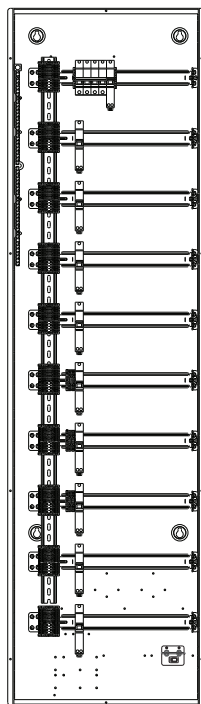

PD10-64-RU10-2L4

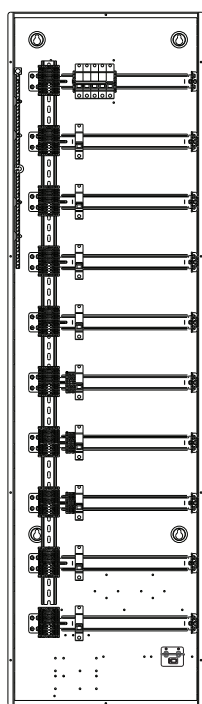

PD10-64-BU10-2L4

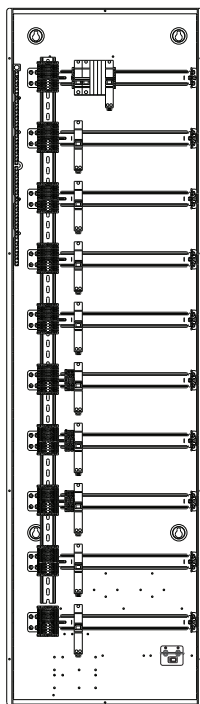

PD10-64-RU10-2L2

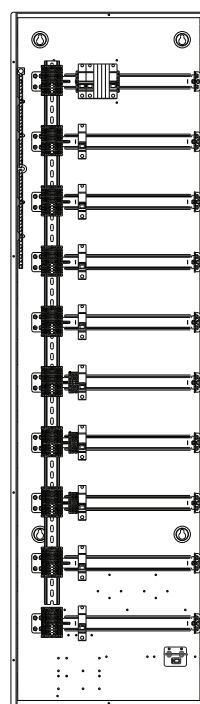

PD10-64-BU10-2L2